

SERIE MCC



Raccordi a Calzamento in Ottone Nichelato
 Brass Nickel-Plated Push-on Fittings
 Raccords à coiffe en laiton nickelé
 Schnellverschraubungen aus Messing vernickelt



I Raccordi a Calzamento della serie MC sono provvisti di un cono di calzamento la cui forma assicura, una volta calzato il tubo e serrato adeguatamente il dado, la perfetta tenuta pneumatica.

Tutti i raccordi della serie MC vengono sottoposti ad un trattamento superficiale di Nichelatura elettrolitica.



The Push-on Fittings of the MC line are provided with a cone to ensure the perfect tightness once the tubing is assembled and the nut tightened. All MC fittings are electrolytic nickel plated.



Les raccords à coiffe de la série MC sont pourvus d'un cône, dont la forme permet, une fois inséré le tube et serré l'écrou, la tenue pneumatique parfaite.

Tous les raccords de la série MC sont soumis à nickelage électrolytique.



Die Überwurfmutterverschraubungen der MC Baureihe sind mit einem Konus versehen, deren Bauform die perfekte pneumatische Dichtheit gewährleistet, nachdem der Schlauch montiert und die Überwurfmutter festgezogen ist.

Alle MC Verschraubungen sind aus Messing, elektrolytisch vernickelt.

1	2
Corpo del raccordo Fitting Body Corps du raccord Verschraubungskörper	Dado Nut Ecrou Überwurfmutter
Ottone UNI EN 12164 CW614N - UNI EN 12165 CW617N Nichelato Brass UNI EN 12164 CW614N - UNI EN 12165 CW617N Nickel Plated Laiton UNI EN 12164 CW614N - UNI EN 12165 CW617N Nickelé Messing UNI EN 12164 CW614N - UNI EN 12165 CW617N vernickelt	Ottone UNI EN 12164 CW614N Nichelato Brass UNI EN 12164 CW614N Nickel Plated Laiton UNI EN 12164 CW614N Nickelé Messing UNI EN 12164 CW614N vernickelt

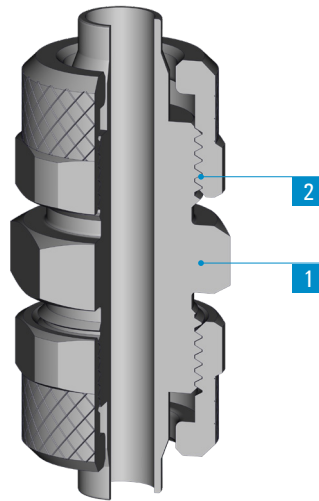
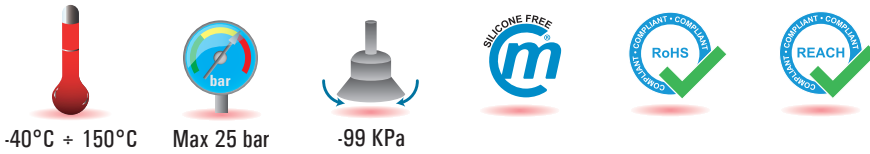

	M5x0,8	G1/8	G1/4	G3/8	G1/2	R1/8	R1/4	R3/8	R1/2
4	●	●				●			
5	●	●				●			
6	●	●	●	●		●	●	●	
8		●	●	●		●	●	●	
10		●	●	●	●	●	●	●	●
12				●	●			●	●
15					●				●

SPECIFICHE TECNICHE

Tubi di collegamento consigliati:
 PA11, PA12, Polietilene PE,
 Poliuretano PU.
 Tolleranze accettabili sui tubi:
 +/- 0,07 mm fino a Ø 10 mm
 +/- 0,1 mm fino Ø 15 mm.

Campi di applicazione:
 Impianti pneumatici.

DATA SHEET

Recommended tubings:
 PA11, PA12, Polyethylene PE,
 Polyurethane PU
 Acceptable Tolerances on the tubings:
 +/- 0,07 mm up to Ø 10 mm
 +/- 0,1 mm up to Ø 15 mm

Application fields:
 Pneumatic circuits.

REINSEIGNEMENTS TECHNIQUES

Tubes conseillés:
 PA11, PA12, PA6, Polyéthylène PE,
 Polyuréthane PU.
 Tolerances sur les tubes:
 +/- 0,07 mm jusqu'au Ø 10 mm
 +/- 0,1 mm jusqu'au Ø 15 mm.

Domaines d'application:
 Circuits pneumatiques.

TECHNISCHE AUSKÜNFTE

Empfohlene Schläuche:
 PA11, PA12, PA6, Polyethylen PE,
 Polyurethan PU.
 Schlauchtoleranzen:
 +/- 0,07 mm bis Ø 10 mm
 +/- 0,1 mm bis Ø 15 mm.

Anwendungsbereiche:
 Pneumatische Anlagen.

ISTRUZIONI DI MONTAGGIO

ASSEMBLY INSTRUCTIONS

INSTRUCTIONS DE MONTAGE

MONTAGEANWEISUNGEN

1. Tagliare il tubo a 90° verificandol'assenza su questo di bave interne ed esterne;
2. Inserire il dado sul tubo;
3. Fare "calzare" il tubo sul cono assicurandosi che vada in battuta;
4. Avvitare il dado di serraggio a mano o servendosi di una chiave.

1. Cut the tube at 90° making sure that no burr is left;
2. Push the nut onto the tube;
3. Push the tube and nut onto the fitting nozzle and make sure that the tube goes all the way up to the nozzle base;
4. Tighten the nut by hand or if necessary by a spanner.

1. Couper le tube à 90° sans laisser des bavures;
2. Faire glisser le tube dans l'écrou;
3. Pousser le tube sur le cône du raccord en faisant attention que le tube appuie jusqu'au fond du cône;
4. Visser l'écrou à la main, ou si nécessaire, par une clé.

1. Schlauch bei 90° abschneiden und entgraten
2. Schlauch in die Überwurfmutter einstecken;
3. Schlauch und Überwurfmutter auf den Verschraubungskonus gleiten lassen bis zum Konusanschlag;
4. Überwurfmutter von Hand oder wenn notwendig mit einem Schlüssel befestigen.

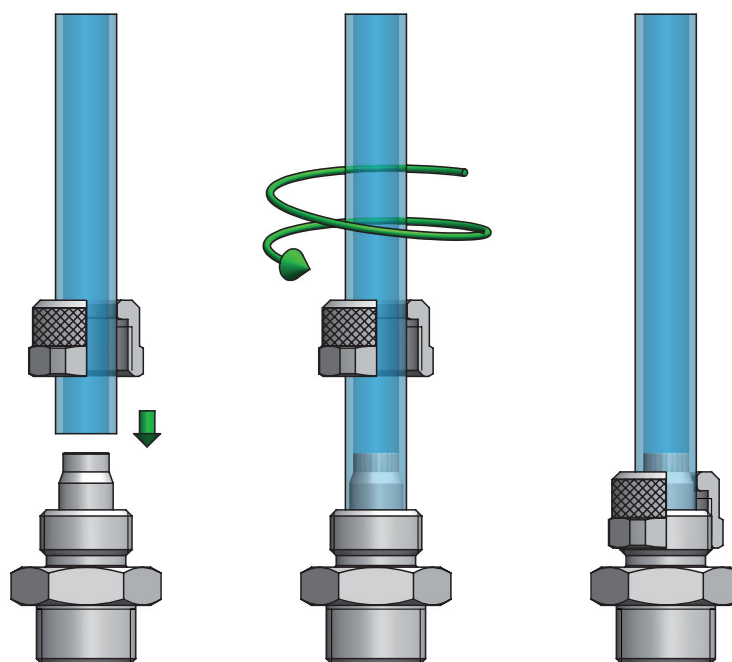

Effettuato il collegamento, assicurarsi che il tubo inserito nel raccordo non sia sottoposto ad alcuna forza di trazione; è necessario inoltre rispettare durante il collegamento del tubo il raggio minimo di curvatura consigliato così come riportato nella sezione tubi di questo catalogo tecnico (vedi pag. 363).
Per il serraggio delle parti filettate del raccordo si raccomanda di attenersi alle coppie consigliate riportate a pag.6



Once the tubing is connected to the fitting, make sure that the tubing is not subject to any tensile strength and that the min. recommended bending radius stated in the tubing section of this catalogue is complied with (see page 363).
To tighten threads, please check out our tightening torque chart illustrated at page 6.



Une fois effectué le branchement, s'assurer que le tube inséré dans le raccord n'est soumis à aucune force de traction. Egalement, il est nécessaire de respecter, lors du branchement du tube, le rayon minimum de courbure conseillé dans la section tubes de ce catalogue technique (voir la page 363).
Pour le serrage des parties filettées du raccord, il est recommandé de s'en tenir aux couples de serrage conseillés et reportés à la page 6.



Nach der Schlauchverbindung, sicherstellen, dass der in die Verschraubung eingeführte Schlauch keinen Zugbelastungen ausgesetzt ist; beim Anschluss des Schlauchs muss der empfohlene Mindestbiegeradius eingehalten werden, gemäß den in diesem technischen Katalog im Schlauchabschnitt, angegebenen Hinweisen (siehe Seite 363).
Zum Festziehen der Gewinde sich an den, auf Seite 6, empfohlenen Drehmomente einhalten.

MC 11

Diritto maschio conico

Taper straight, male

Union simple mâle conique

Gerade Einschraubverschraubung, kegelig

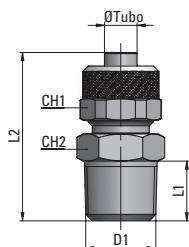

Type	Ø Tubo	D1	L1	L2	CH1	CH2	g Δ
11 04 18	4-2,5	R1/8	7,5	23,5	7	11	7,4
11 05 18	5-3	R1/8	8	25	8	12	8,6
11 06 18	6-4	R1/8	8	27,5	12	12	15
11 06 14	6-4	R1/4	11	31	12	14	20,6
11 06 38	6-4	R3/8	11,5	31,5	12	17	23,9
11 08 18	8-6	R1/8	8	27,5	14	12	17,7
11 08 14	8-6	R1/4	11	31	14	14	22,5
11 08 38	8-6	R3/8	11,5	31,5	14	17	27,4
11 10 18	10-8	R1/8	8	29,5	16	14	22
11 10 14	10-8	R1/4	11	32,5	16	14	26,6
11 10 38	10-8	R3/8	11,5	33	16	17	33,1
11 10 12	10-8	R1/2	14	36	16	22	48,3
11 12 38	12-10	R3/8	11,5	34,5	18	17	37,3
11 12 12	12-10	R1/2	14	37,5	18	22	49,5
11 15 12	15-12,5	R1/2	14	39,5	22	22	61,9

MC 12

Diritto maschio cilindrico

Parallel straight, male

Union simple mâle cylindrique

Gerade Einschraubverschraubung, zylindrisch

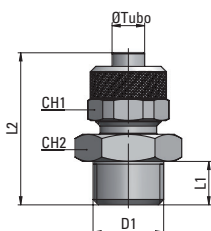

Type	Ø Tubo	D1	L1	L2	CH1	CH2	g Δ
12 04 M5	4-2,5	M5x0,8	5	20	7	7	3,4
12 04 18	4-2,5	G1/8	6	22,5	7	14	9,7
12 05 M5	5-3	M5x0,8	4	20	8	8	4,8
12 05 18	5-3	G1/8	6	23	8	14	10,6
12 06 M5	6-4	M5x0,8	4	21	9	8	6,1
12 06 18	6-4	G1/8	6	25,5	12	14	16,4
12 06 14	6-4	G1/4	8	28	12	17	21
12 06 38	6-4	G3/8	9	29	12	19	27,5
12 08 18	8-6	G1/8	6	25,5	14	14	19,5
12 08 14	8-6	G1/4	8	28	14	17	25,2
12 08 38	8-6	G3/8	9	29	14	19	30,1
12 10 18	10-8	G1/8	6	27,5	16	14	22,9
12 10 14	10-8	G1/4	8	29,5	16	17	29,4
12 10 38	10-8	G3/8	9	30,5	16	19	32,6
12 10 12	10-8	G1/2	10	32	16	24	45,1
12 12 38	12-10	G3/8	9	32	18	19	38,1
12 12 12	12-10	G1/2	10	33,5	18	24	53,2
12 15 12	15-12,5	G1/2	10	33,5	22	24	60,9

MC 13

Diritto femmina

Female straight

Union simple femelle

Gerade Aufschraubverschraubung

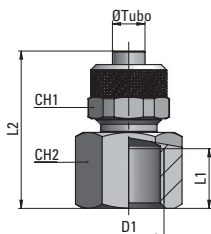

Type	Ø Tubo	D1	L1	L2	CH1	CH2	g Δ
13 05 18	5-3	G1/8	8	22,5	8	14	12,4
13 06 18	6-4	G1/8	8	25	12	14	17,8
13 06 14	6-4	G1/4	11	29	12	17	25,8
13 08 18	8-6	G1/8	8	25	14	14	20,1
13 08 14	8-6	G1/4	11	29	14	17	27,5
13 08 38	8-6	G3/8	11,5	29,5	14	20	31,1
13 10 14	10-8	G1/4	11	30,5	16	17	32,2
13 10 38	10-8	G3/8	11,5	31	16	20	36,1
13 12 38	12-10	G3/8	11,5	32,5	18	20	39,7

MC 14

Giunzione intermedia

Union

Union simple égale

Gerade Verbindung

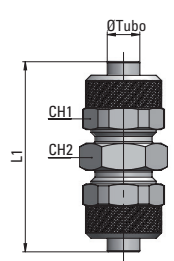

Type	Ø Tubo	D1	CH1	CH2	g Δ
14 05 05	5-3	28,5	8	8	7,5
14 06 06	6-4	34,5	12	12	20,5
14 08 08	8-6	35	14	14	27,9
14 10 10	10-8	38	16	14	36
14 12 12	12-10	41	18	17	47
14 15 15	15-12,5	45,5	22	22	74,6

MC 15

Giunzione intermedia passaparte

Bulkhead union

Union traversée de cloison

Gerade Schottverschraubung

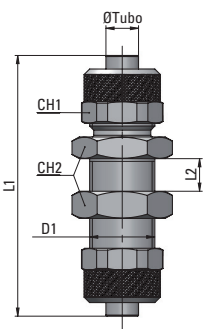

Type	Øe Tubo	D1	L1	L2	CH1	CH2	g Δ
15 05 05	5-3	M7x0,75	40	8,5	8	9	10,9
15 06 06	6-4	M10x1	48	10,5	12	14	33,2
15 08 08	8-6	M12x1	48	10,5	14	16	42,6
15 10 10	10-8	M14x1	50	8,5	16	17	56
15 12 12	12-10	M16x1	53	8,5	18	19	75,3
15 15 15	15-12,5	M20x1	58	8,5	22	24	104,6

MC 16

Gomito maschio conico

Taper elbow fitting, male

Raccord à coude mâle conique

Winkelverschraubung, kegelig

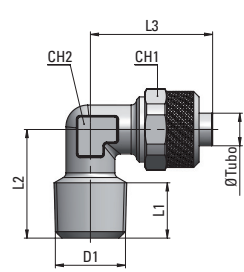

Type	Ø Tubo	D1	L1	L2	L3	CH1	CH2	g Δ
16 04 M5	4-2,5	M5x0,8	5	15,5	20	7	9	10,4
16 04 18	4-2,5	R1/8	7,5	17	20	7	9	10,7
16 05 18	5-3	R1/8	8	17	21,5	8	8	10,8
16 06 18	6-4	R1/8	8	17	22,5	12	8	16,2
16 06 14	6-4	R1/4	11	20	22,5	12	10	21,6
16 06 38	6-4	R3/8	11,5	22,5	23,5	12	11	30,3
16 08 18	8-6	R1/8	8	17	22,5	14	10	19,4
16 08 14	8-6	R1/4	11	20	22,5	14	10	23,3
16 08 38	8-6	R3/8	11,5	22,5	24	14	11	31
16 10 18	10-8	R1/8	8	18,5	25,5	16	11	27,6
16 10 14	10-8	R1/4	11	21,5	25,5	16	11	30,5
16 10 38	10-8	R3/8	11,5	22,5	25,5	16	11	34,7
16 12 38	12-10	R3/8	11,5	24,5	30	18	14	46
16 12 12	12-10	R1/2	14	28	30,5	18	17	66,5
16 15 12	15-12,5	R1/2	14	28	34	22	17	69,6

MC 17

Gomito femmina

Female elbow

Raccord à coude femelle

Winkel-Aufschraubverschraubung

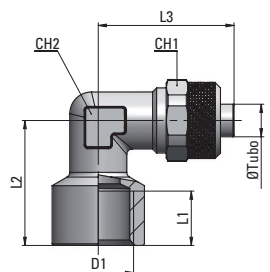

Type	Ø Tubo	D1	L1	L2	L3	CH1	CH2	g Δ
17 05 18	5-3	G1/8	8	19	21,5	8	10	20,8
17 06 18	6-4	G1/8	8	19	22,7	12	10	20,5
17 06 14	6-4	G1/4	11	23	24,5	12	11	30,6
17 08 18	8-6	G1/8	8	19	22,7	14	10	23
17 08 14	8-6	G1/4	11	23	25	14	11	31
17 10 14	10-8	G1/4	11	23,5	26	16	13	39,2
17 12 38	12-10	G3/8	11,5	28	30,5	18	17	61,3

MC 18

Gomito intermedio

Union elbow

Raccord à coude

Winkerverschraubung

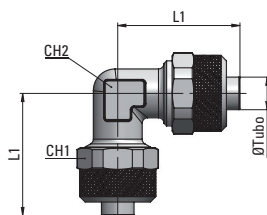

Type	Ø Tubo	L1	CH1	CH2	g Δ
18 05 05	5-3	21,5	8	8	13,1
18 06 06	6-4	21,5	12	8	22,7
18 08 08	8-6	22,5	14	10	28,4
18 10 10	10-8	25,5	16	11	38,6
18 12 12	12-10	30	18	14	58
18 15 15	15-12,5	34	22	17	84,3

MC 19

T intermedio

Union tee

T égal

T-Verschraubung

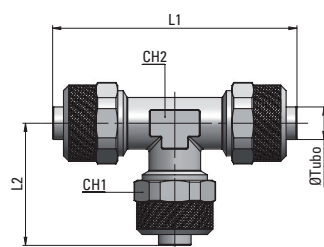

Type	Ø Tubo	L1	L2	CH1	CH2	g Δ
19 05 05	5-3	43	21,5	8	8	18,6
19 06 06	6-4	45	22,5	12	8	32,1
19 08 08	8-6	45	22,5	14	10	41,3
19 10 10	10-8	51	25,5	16	11	54,5
19 12 12	12-10	60	30	18	14	84,9
19 15 15	15-12,5	68	34	22	17	124,2

MC 20

T centrale conico

Taper male tee

T mâle, central

T-Einschraubverschraubung

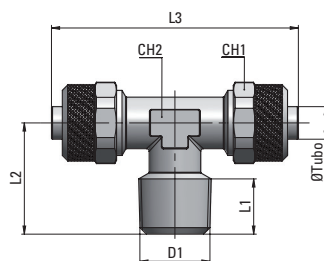

Type	Ø Tubo	D1	L1	L2	L3	CH1	CH2	g Δ
20 05 18	5-3	R1/8	8	17	43	8	8	17,5
20 06 18	6-4	R1/8	8	17	45	12	8	27
20 06 14	6-4	R1/4	11	20,5	45,5	12	10	35,2
20 08 18	8-6	R1/8	8	17,5	45,5	14	10	33,6
20 08 14	8-6	R1/4	11	20,5	45,5	14	10	37,7
20 10 14	10-8	R1/4	11	21,5	51	16	11	48
20 10 38	10-8	R3/8	11,5	22,5	51	16	11	51,1
20 12 38	12-10	R3/8	11,5	24,5	60	18	14	69,5
20 12 12	12-10	R1/2	14	28	61	18	17	99,4
20 15 12	15-12,5	R1/2	14	28	68	22	17	108,3

MC 21

T laterale conico

Taper lateral tee

T mâle, latéral

T-Einschraubverschraubung

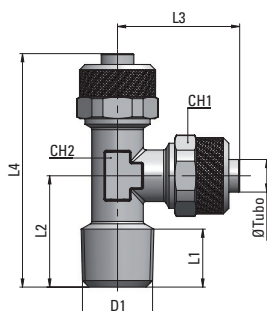

Type	Ø Tubo	D1	L1	L2	L3	L4	CH1	CH2	g Δ
21 05 18	5-3	R1/8	8	17	21,5	38,5	8	8	17,7
21 06 18	6-4	R1/8	8	17	22,5	39,5	12	8	25,8
21 06 14	6-4	R1/4	11	20,7	22,7	43,5	12	10	33,8
21 08 18	8-6	R1/8	8	17,7	22,7	40,5	14	10	36,9
21 08 14	8-6	R1/4	11	20,7	22,7	43,5	14	10	36,3
21 10 14	10-8	R1/4	11	21	25,5	46,5	16	11	47,4
21 10 38	10-8	R3/8	11,5	22,5	25,5	48	16	11	51,2
21 12 38	12-10	R3/8	11,5	24,5	30	54,5	18	14	72,2
21 12 12	12-10	R1/2	14	28	30,5	58,5	18	17	99,1
21 15 12	15-12,5	R1/2	14	28	34	62	22	17	107,1

MC 22

Croce

Cross fitting

Raccord à croix

Kreuzstück

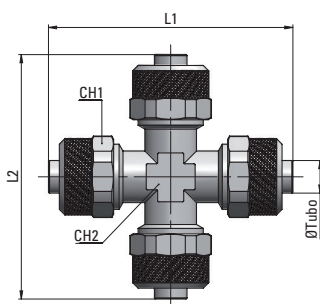

Type	Ø Tubo	L1	L2	CH1	CH2	g $\Delta\Delta$
22 05 00	5-3	43	43	8	8	45,4
22 06 00	6-4	45	45	12	8	45,6
22 08 00	8-6	45	45	14	10	53,1
22 10 00	10-8	51	51	16	11	72,3

MC 23

Anello singolo

Single banjo ring

Banjo simple

Ringstück

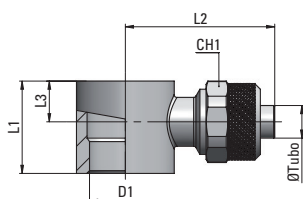

Type	Ø Tubo	D1	L1	L2	L3	CH1	g $\Delta\Delta$
23 04 M5	4-2,5	5,1	9	19	4,5	7	7,6
23 04 M5 /R	4-2,5	7	10	19	3,5	7	5,5
23 04 18	4-2,5	10	15	21,5	6	7	12,7
23 05 M5	5-3	5,1	9	20	4,5	8	7,3
23 05 M5 /R	5-3	7	10	20	3,5	8	6,5
23 05 18	5-3	10	15	23	6	8	20,5
23 06 M5	6-4	5,1	9	20	4,5	9	7,9
23 06 M5 /R	6-4	7	10	20	3,5	9	6,8
23 06 18	6-4	10	15	25	6	12	19,2
23 06 14	6-4	13,2	17	26,5	7,5	12	25,6
23 08 18	8-6	10	15	25	6	14	19,5
23 08 14	8-6	13,2	17	27,5	7,5	14	27,4
23 08 38	8-6	17	20	29,5	7,5	14	39
23 10 14	10-8	13,2	17	28,5	7,5	16	29,2
23 10 38	10-8	17	20	30,5	7,5	16	41,5

/R = Solo per regolatori di flusso - For flow controls only - Seulement pour les réducteurs de débit - Nur für Drosselrückschlagventil

MC 24

Anello doppio

Double banjo ring

Banjo double

Zweifaches Ringstück

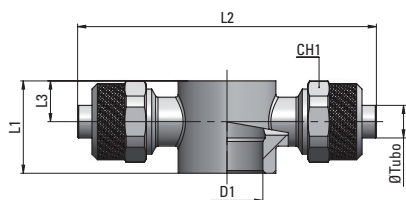

Type	Ø Tubo	D1	L1	L2	L3	CH1	g $\Delta\Delta$
24 05 M5	5-3	5,1	9	40	4,5	8	12
24 05 18	5-3	10	15	50	6	12	30,6
24 06 M5	6-4	5,1	9	40	4,5	9	12,7
24 06 18	6-4	10	15	50	6	12	30,1
24 06 14	6-4	13,2	17	53	7,5	12	35,5
24 08 18	8-6	10	15	50	6	14	31,9
24 08 14	8-6	13,2	17	55	7,5	14	38,9
24 08 38	8-6	17,1	20	59	7,5	14	51,4
24 10 14	10-8	13,2	17	57	7,5	16	44,5
24 10 38	10-8	17	20	61	7,5	16	56,1

MC 27

Dado

Nut

Écrou

Überwurfmutter

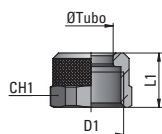

Type	Ø Tubo	D1	L1	CH1	g Δ
27 04 07	4-2,5	M6x0,75	8	7	1,1
27 05 08	5-3	M7x0,75	9	8	1,2
27 06 08	6-4	M8x0,75	9	9	1,5
27 06 10	6-4	M10x1	10	12	4,1
27 08 12	8-6	M12x1	10	14	5
27 10 14	10-8	M14x1	11,5	16	6,5
27 12 16	12-10	M16x1	13	18	8,8
27 15 20	15-12,5	M20x1	15,5	22	14,3

MC 29

Diritto girevole conico

Swivelling taper straight

Union simple tournante, cônica

Gerade Verschraubung, kegelig

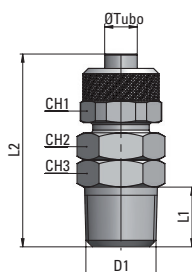

Type	Ø Tubo	D1	L1	L2	CH1	CH2	CH3	g Δ
29 06 18	6-4	R1/8	8	37	12	12	12	16,3
29 06 14	6-4	R1/4	11	40	12	14	14	27,2
29 08 18	8-6	R1/8	8	37	14	12	12	20,4
29 08 14	8-6	R1/4	11	40	14	14	14	30,6
29 10 14	10-8	R1/4	11	42	16	14	14	32,1

Guarnizioni in NBR - NBR seals - Joint d'étanchéité en NBR - NBR Dichtung



-20°C + 80°C



Max 18 bar

MC 30

Girevole con anello singolo

Swivelling fitting with banjo ring

Raccord tournant avec banjo

Schwenkverschraubung mit Ringstück

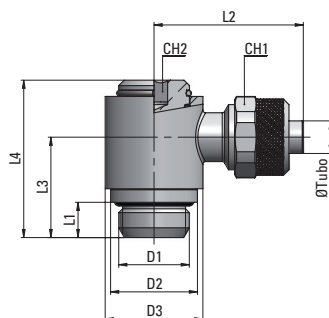

Type	Ø Tubo	D1	D2	D3	L1	L2	L3	L4	CH1	CH2	g Δ
30 06 18	6-4	G1/8	13	14	5	25	16,5	25,5	12	4	28,2
30 06 14	6-4	G1/4	16	18	6,5	26,5	18,5	29	12	5	41,9
30 08 18	8-6	G1/8	13	14	5	25	16,5	25,5	14	4	28,7
30 08 14	8-6	G1/4	16	18	6,5	27,5	18,5	29	14	5	44,1
30 10 14	10-8	G1/4	16	18	6,5	28,5	18,5	29	16	5	46,7
30 10 38	10-8	G3/8	20	22	7	30,5	22	32,5	16	6	68,7

Guarnizioni NBR - NBR Seals - Joint d'étanchéité NBR - NBR Dichtung



-20°C + 80°C



Max 18 bar

MC 31

Girevole con anello doppio

Swivelling fitting with double banjo ring

Raccord tournant avec banjo double

Drehbare Verschraubung mit zweifachem Ringstück

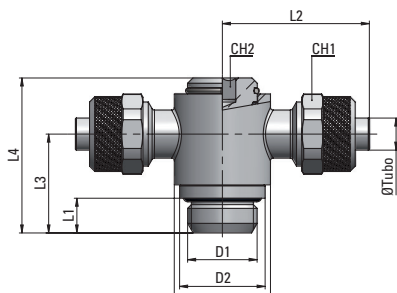

Type	Ø Tubo	D1	D2	D3	L1	L2	L3	L4	CH1	CH2	g Δ
31 06 18	6-4	G1/8	13	14	5	25	16,5	25,5	12	4	39,2
31 06 14	6-4	G1/4	16	18	6,5	26,5	18,5	29	12	5	52,9
31 08 18	8-6	G1/8	14	14	5	25	16,5	25,5	14	4	41,2
31 08 14	8-6	G1/4	16	18	6,5	27,5	18,5	29	14	5	56
31 10 14	10-8	G1/4	16	18	6,5	28,5	18,5	29	16	5	64
31 10 38	10-8	G3/8	20	22	7	30,5	22	32,5	16	8	84,6

Guarnizioni NBR - NBR Seals - Joint d'étanchéité NBR - NBR Dichtung

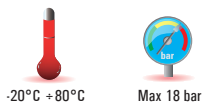

MC 32

Dado con molla

Nut with protection spring

Ecrou avec ressort de protection

Überwurfmutter mit Schutzfeder

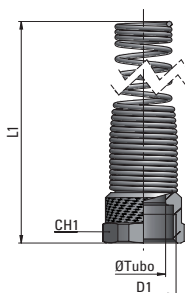

Type	Ø Tubo	D1	L1	CH1	g Δ
32 06 04	6-4	M10x1	95	12	13,3
32 08 06	8-6	M12x1	93,5	14	17,1
32 10 08	10-8	M14x1	96,5	16	30,4

MC 34

Anello singolo orientabile

Swivelling elbow

Raccord à coude tournant

Schwenverschraubung

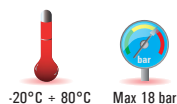
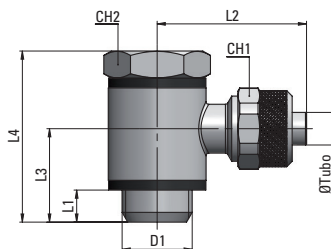

Type	Ø Tubo	D1	L1	L2	L3	L4	CH1	CH2	g Δ
34 04 M5	4-2,5	M5x0,8	4,1	19	9,8	18,5	7	8	10,4
34 04 18	4-2,5	G1/8	4,4	21,5	15,2	27	7	14	27,5
34 05 M5	5-3	M5x0,8	4,1	20	9,8	18,5	8	8	10
34 05 18	5-3	G1/8	4,4	23	15,2	27	8	14	27
34 06 M5	6-4	M5x0,8	4,1	20	9,8	18,5	9	8	10,8
34 06 18	6-4	G1/8	4,4	25	15,2	27	12	14	32,5
34 06 14	6-4	G1/4	5,9	26,5	17,2	31,5	12	17	52,4
34 08 18	8-6	G1/8	4,4	25	15,2	27	14	14	33,6
34 08 14	8-6	G1/4	5,9	27,5	17,2	31,5	14	17	54,6
34 08 38	8-6	G3/8	6,4	29,5	20,7	36	14	20	83,4
34 10 14	10-8	G1/4	5,9	28,5	17,2	31,5	16	17	56,7
34 10 38	10-8	G3/8	6,4	30,5	20,7	36	16	20	86,2

Rondella in plastica PA6 - sealing ring - Bague étanchéité en PA6 - PA6 Dichtring

MC 36

T centrale orientabile

Swivelling tee

Raccord à té tournant

T-Schwenverschraubung

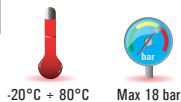
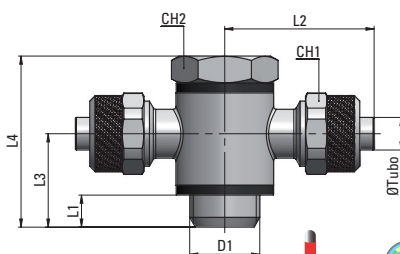

Type	Ø Tubo	D1	L1	L2	L3	L4	CH1	CH2	g Δ
36 05 M5	5-3	M5x0,8	4,1	20	9,8	18,5	8	8	14,3
36 05 18	5-3	G1/8	4,4	23	15,2	27	8	14	44,5
36 06 M5	6-4	M5x0,8	4,1	20	9,8	18,5	9	8	15,3
36 06 18	6-4	G1/8	4,4	25	15,2	27	12	14	44,1
36 06 14	6-4	G1/4	5,9	26,5	17,2	31,5	12	17	63,2
36 08 18	8-6	G1/8	4,4	25	15,2	27	14	14	46,3
36 08 14	8-6	G1/4	5,9	27,5	17,2	31,5	14	17	66,5
36 08 38	8-6	G3/8	6,4	29,5	20,7	36	14	20	96,2
36 10 14	10-8	G1/4	5,9	28,5	17,2	31,5	16	17	72,4
36 10 38	10-8	G3/8	6,4	30,5	20,7	36	16	20	103,3

Rondella in plastica PA6 - sealing ring - Bague étanchéité en PA6 - PA6 Dichtring