

SERIE MCX

MCX



Raccordi a Calzamento in Acciaio Inox 316L
316L Stainless Steel Push-on Fittings
Raccords à coiffe en Acier Inox 316L
Schnellverschraubungen aus Edelstahl 1.4404



I "Raccordi a Calzamento" della serie CX grazie all'assenza di guarnizioni di tenuta e alla realizzazione del raccordo completamente in acciaio inossidabile AISI316L trovano applicazione in caso di temperature molto elevate e dove è necessario convogliare fluidi aggressivi non compatibili con guarnizioni in FPM.



The CX is a "push on" fitting made of AISI 316L, completely free of Orings since conceived for heavy duty applications involving high temperatures, aggressive fluids and where also FPM Oring would not be suitable.



Les raccords à coiffe de la série CX sont en AISI 316L et complètement sans joints d'étanchéités, car conçu pour les emplois les plus lourdes comme en cas de température très élevée ou avec fluids très agressifs, avec lesquels les joints d'étanchéité en FPM ne sont pas compatibles.



Unsere Überwürfmutterverschraubung aus AISI 316L ist ohne Dichtungen entwickelt worden, da sie als Idealserie für bestimmte Hochleistungsanwendungen, wie bei sehr hohen Temperaturen oder im Einsatz mit aggressiven Flüssigkeiten, wo FPM nicht kompatibel ist, gedacht ist.

1	2	3
Corpo Body Corps Körper	Dado Nut Ecrou Überwurfmutter	Guarnizioni Seals Joint d'étanchéité Dichtung
Acciaio Inox AISI 316L (1.4404) Stainless Steel AISI 316L (1.4404) Acier Inox AISI 316L (1.4404) Edelstahl AISI 316L (1.4404)	Acciaio Inox AISI 316L (1.4404) Stainless Steel AISI 316L (1.4404) Acier Inox AISI 316L (1.4404) Edelstahl AISI 316L (1.4404)	FPM FDA FPM FDA FPM FDA



-40°C + 250°C



Max 25 bar

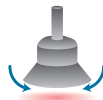

-99 KPa

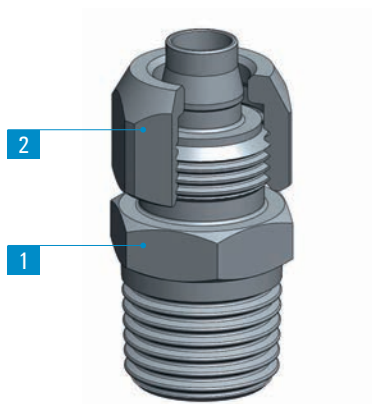

	R1/8	R1/4	R3/8	R1/2
6	●	●		
8	●	●		
10		●	●	
12		●	●	●

SPECIFICHE TECNICHE

Tubi di collegamento consigliati:
Tubo in PTFE
Tolleranze accettabili sui tubi:
+/- 0,07 mm fino a Ø 10 mm
+/- 0,1 mm fino Ø 12 mm.

Campi di applicazione:
Pneumatica, Industria Alimentare, Chimica
e Medicale-Farmaceutica.

DATA SHEET

Recommended tubings:
PTFE tubings
Acceptable Tolerances on the tubings: +/-
0,07 mm up to Ø 10 mm
+/- 0,1 mm up to Ø 12 mm

Application fields:
Pneumatics, Food Industry, Chemical,
Medical and Pharmaceutical Industry.

REINSEIGNEMENTS TECHNIQUES

Tubes conseillés:
Tube PTFE.
Tolerances sur les tubes:
+/- 0,07 mm jusqu'au Ø 10 mm
+/- 0,1 mm jusqu'au Ø 12 mm.

Domaines d'application:
Pneumatique, Industrie alimentaire,
Chimique, Médicale et Pharmaceutique.

TECHNISCHE AUSKÜNFTE

Empfohlene Schläuche:
PTFEschlauch.
Schlauchtoleranzen:
+/- 0,07 mm bis Ø 10 mm
+/- 0,1 mm bis Ø 12 mm.

Anwendungsbereiche:
Pneumatik, Nahrungsindustrie, chemische, medi-
kale und pharmazeutische Industrie.

ISTRUZIONI DI MONTAGGIO

ASSEMBLY INSTRUCTIONS

INSTRUCTIONS DE MONTAGE

MONTAGEANWEISUNGEN

1. Tagliare il tubo a 90° verificando l'assenza su questo di bave interne ed esterne;
2. Inserire il dado sul tubo;
3. Fare "calzare" il tubo sul cono assicurandosi che vada in battuta;
4. Avvitare il dado di serraggio a mano o servendosi di una chiave.

1. Cut the tube at 90° making sure that no burr is left;
2. Push the nut onto the tube;
3. Push the tube and nut onto the fitting nozzle and make sure that the tube goes all the way up to the nozzle base;
4. Tighten the nut by hand or if necessary by a spanner.

1. Couper le tube à 90° sans laisser des bavures;
2. Faire glisser le tube dans l'écrou;
3. Pousser le tube sur le cône du raccord en faisant attention que le tube appuye jusqu'au fond du cône;
4. Visser l'écrou à la main, ou si nécessaire, par une clé.

1. Schlauch bei 90° abschneiden und entgraten
2. Schlauch in die Überwurfmutter einstecken;
3. Schlauch und Überwurfmutter auf den Verschraubungskonus gleiten lassen bis zum Konusanschlag;
4. Überwurfmutter von Hand oder wenn notwendig mit einem Schlüssel befestigen.

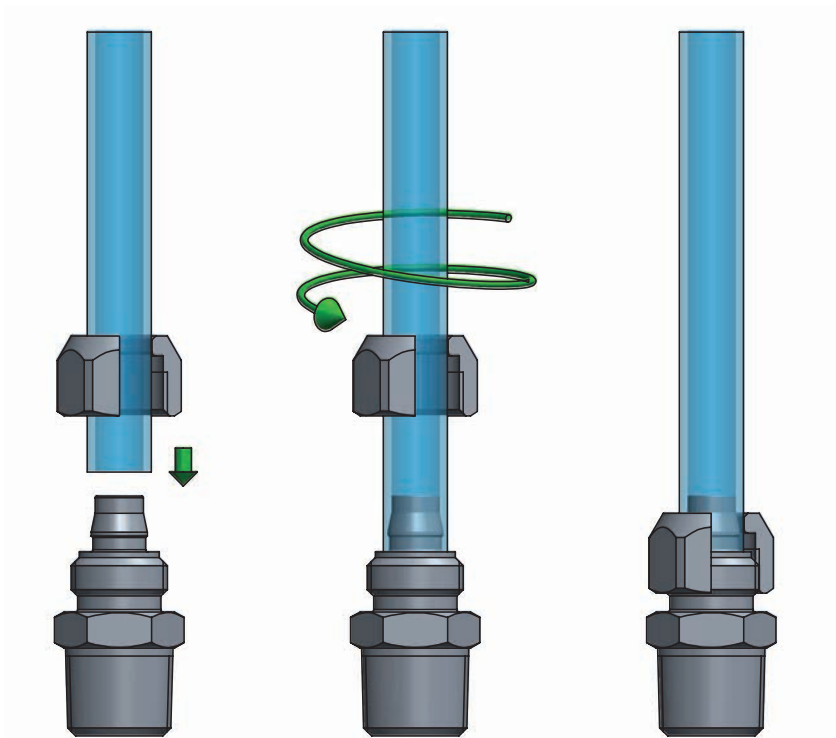

 Effettuato il collegamento, assicurarsi che il tubo inserito nel raccordo non sia sottoposto ad alcuna forza di trazione; è necessario inoltre rispettare durante il collegamento del tubo il raggio minimo di curvatura consigliato così come riportato nella sezione tubi di questo catalogo tecnico (vedi pag. 363)
Per il serraggio delle parti filettate del raccordo si raccomanda di attenersi alle coppie consigliate riportate a pag.6

 Once the tubing is connected to the fitting, make sure that the tubing is not subject to any tensile strength and that the min. recommended bending radius stated in the tubing section of this catalogue is complied with (see page 363). To tighten threads, please check out our tightening torque chart illustrated at page 6.

 Une fois effectué le branchement, s'assurer que le tube inséré dans le raccord n'est soumis à aucune force de traction. Egalement, il est nécessaire de respecter, lors du branchement du tube, le rayon minimum de courbure conseillé dans la section tubes de ce catalogue technique (voir la page 363).
Pour le serrage des parties filettées du raccord, il est recommandé de s'en tenir aux couples de serrage conseillés et reportés à la page 6.

 Nach der Schlauchverbindung, sicherstellen, dass der in die Verschraubung eingeführte Schlauch keinen Zugbelastungen ausgesetzt ist; beim Anschluss des Schlauchs muss der empfohlene Mindestbiegeradius eingehalten werden, gemäß den in diesem technischen Katalog im Schlauchabschnitt, angegebenen Hinweisen (siehe Seite 363).
Zum Festziehen der Gewinde sich an den, auf Seite 6, empfohlenen Drehmomente einhalten.

CX 10

Dado

Nut

Écrou

Überwurfmutter

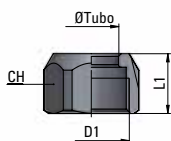

Type	Ø Tubo	D1	L1	CH	g Δ
10 06 10	6-4	M10x1	10	12	4,4
10 08 12	8-6	M12x1	10	14	5,5
10 10 14	10-8	M14x1	11	16	7
new 10 12 16	12-10	M16x1	12	19	-

CX 11

Diritto maschio conico

Taper straight, male

Union simple mâle conique

Gerade Einschraubverschraubung, kegelig

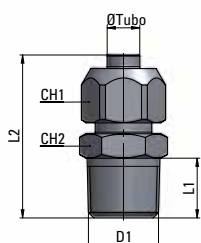

Type	Ø Tubo	D1	L1	L2	CH1	CH2	g Δ
11 06 18	6-4	R1/8	7,5	26	12	10	11,6
11 06 14	6-4	R1/4	11	29,5	12	14	17,5
11 08 18	8-6	R1/8	7,5	26,5	14	13	16,5
11 08 14	8-6	R1/4	11	30	14	14	20,3
11 10 14	10-8	R1/4	11	32,5	16	14	23,6
11 10 38	10-8	R3/8	11,5	33	16	17	29,9
new 11 12 14	12-10	R1/4	11	34	19	17	34,8
new 11 12 38	12-10	R3/8	11,5	34,5	19	17	-
new 11 12 12	12-10	R1/2	14	38	19	22	-

CX 13

Diritto femmina

Female straight

Union simple femelle

Gerade Aufschraubverschraubung

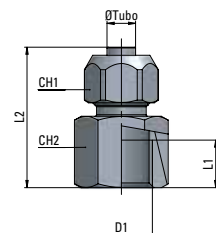

Type	Ø Tubo	D1	L1	L2	CH1	CH2	g Δ
13 06 18	6-4	G1/8	7	25	12	13	14,6
13 06 14	6-4	G1/4	10	28,5	12	17	22,8
13 08 18	8-6	G1/8	7	25,5	14	13	-
13 08 14	8-6	G1/4	10	29,5	14	17	26,9
13 08 38	8-6	G3/8	11	31	14	21	-
13 10 14	10-8	G1/4	10	31,5	16	17	-
13 10 38	10-8	G3/8	11	33	16	17	40,8
new 13 12 38	12-10	G3/8	11	34,5	19	21	-
new 13 12 12	12-10	G1/2	11	35	19	24	-

CX 14

Gomito maschio conico

Taper elbow fitting, male

Raccord à coude mâle conique

Winkerverschraubung, kegelig

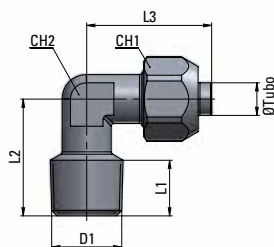

Type	Ø Tubo	D1	L1	L2	L3	CH1	CH2	g Δ
14 06 18	6-4	R1/8	6,5	17	23	12	10	16,6
14 06 14	6-4	R1/4	10	21,5	23	12	10	20,5
14 08 18	8-6	R1/8	6,5	17	23,5	14	10	17,6
14 08 14	8-6	R1/4	10	21,5	23,5	14	10	21,1
14 10 14	10-8	R1/4	9,5	21,5	26	16	12	29,5
new 14 10 38	10-8	R3/8	11	24	26	16	12	-
new 14 12 38	12-10	R3/8	12,6	35,5	30,5	19	17	-
new 14 12 12	12-10	R1/2	13,5	30	33	19	19	-

CX 15

Gomito maschio conico girevole

Taper swivelling elbow fitting, male

Raccord à coude tournant, mâle conique

Schwenkbare Winkerverschraubung, kegelig

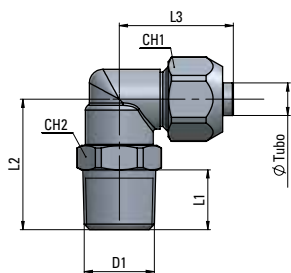

Type	Ø Tubo	D1	L1	L2	L3	CH1	CH2	g	Δ
new 15 06 18	6-4	R1/8	7,5	20	21	12	13	-	-
new 15 06 14	6-4	R1/4	11	24	21	12	14	-	-
new 15 08 18	8-6	R1/8	7,5	20	21	14	13	-	-
new 15 08 14	8-6	R1/4	11	24	21	14	14	-	-
new 15 10 14	10-8	R1/4	11	25,5	24	16	14	-	-
new 15 10 38	10-8	R3/8	11,5	26	24	16	17	-	-

Guarnizioni FPM - FPM Seals - Joint d'étanchéité FPM - FPM Dichtung

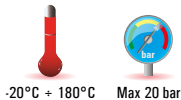

CX 20

T centrale conico

Taper male tee

T mâle, central

T-Einschraubverschraubung

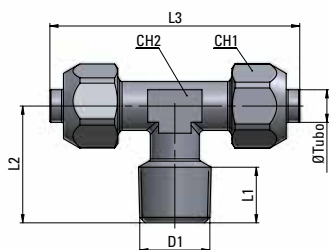

Type	Ø Tubo	D1	L1	L2	L3	CH1	CH2	g	Δ
20 06 18	6-4	R1/8	6,5	17	46	12	10	29	-
20 06 14	6-4	R1/4	9,5	21	46	12	10	31,6	-
20 08 18	8-6	R1/8	6,5	17	46	14	10	30,3	-
20 08 14	8-6	R1/4	10	21,5	46	14	10	33,7	-
20 10 14	10-8	R1/4	9,5	21,5	52	16	12	39,7	-
new 20 10 38	10-8	R3/8	11	24	52	16	12	-	-
new 20 12 38	12-10	R3/8	12,6	60	52	19	17	-	-
new 20 12 12	12-10	R1/2	13,9	60	52	19	17	-	-

CX 23

T laterale conico

Taper lateral tee

T mâle, latéral

T-Einschraubverschraubung

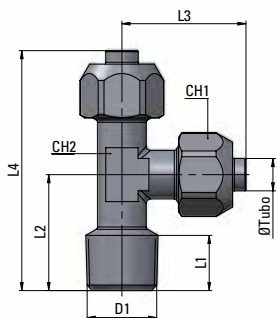

Type	Ø Tubo	D1	L1	L2	L3	L4	CH1	CH2	g	Δ
23 06 18	6-4	R1/8	9,9	17	23	40	12	10	28,3	-
23 06 14	6-4	R1/4	10	21,5	23	44,5	12	10	31,2	-
23 08 18	8-6	R1/8	6,5	17	23	40	14	10	30,4	-
23 08 14	8-6	R1/4	10	21,5	23	44,5	14	10	34,1	-
23 10 14	10-8	R1/4	9,5	21,5	26	47,5	16	12	39,5	-
new 23 10 38	10-8	R3/8	11	24	26	50	16	12	-	-
new 23 12 38	12-10	R3/8	12,6	25,5	30	55,5	19	17	-	-
new 23 12 12	12-10	R1/2	13,9	28	30	58	19	17	-	-

CX 26

Giunzione intermedia

Union

Union simple égale

Gerade Verbindung

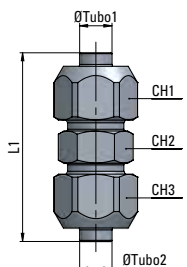

Type	Ø Tubo1	Ø Tubo2	L1	CH1	CH2	CH3	g	Δ
26 06 06	6-4	6-4	34	12	10	12	20	-
26 08 08	8-6	8-6	35	14	12	14	25,7	-
new 26 08 06	8-6	6-4	34,5	14	12	12	23,5	-
26 10 10	10-8	10-8	39	16	14	16	35,8	-
new 26 10 08	10-8	8-6	37	16	14	14	-	-
new 26 12 12	12-10	12-10	42	19	16	19	-	-
new 26 12 10	12-10	10-8	40,5	19	16	16	-	-

CX 28

Gomito intermedio

Union elbow

Raccord à coude

Winkelverschraubung

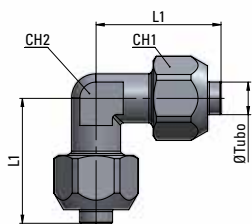

Type	Ø Tubo	L1	CH1	CH2	g
28 06 06	6-4	23	12	10	24,9
28 08 08	8-6	23,5	14	10	26,9
28 10 10	10-8	26	16	12	33,3
new 28 12 12	12-10	30	19	17	-

CX 29

T intermedio

Union tee

T égal

T-Verschraubung

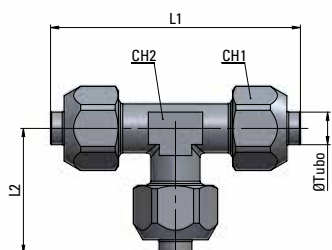

Type	Ø Tubo	L1	L2	CH1	CH2	g
29 06 06	6-4	46	23	12	10	36,4
29 08 08	8-6	46	23	14	10	39
29 10 10	10-8	52	26	16	12	47,6
new 29 12 12	12-10	60	30	19	17	-